



7490

Flat Nose Pliers with Dual-Component Synthetic Handle





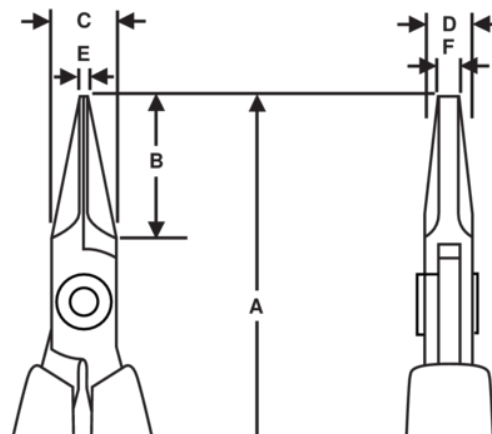

PRODUCT DETAILS

- Supreme series flat nose pliers
- ESD safe mono-material handles with return spring
- High performance alloyed steel
- Polished finish
- Numerically controlled machine grinding guarantees accuracy & increases the tools reliability & consistency
- Tough hardened 42-46 HRC
- Screw joint that minimizes friction & maximizes jaw alignment
- 20 mm of smooth gripping jaws with radiused edges







PRODUCT ATTRIBUTES

Product: **7490**

	Flat Nose		S	A	146.5 mm
A	5.77 in	B	20 mm	B	0.79 in
C	9 mm	C	0.35 in	D	6 mm
D	0.24 inch	E	1.2 mm	E	0.05 in
F	3.2 mm	F	0.13 in		Smooth
	70 g	Ω	Dissipative		

Product: **7490 CO**

	Flat Nose		S	A	146.5 mm
A	5.77 in	B	20 mm	B	0.79 in
C	9 mm	C	0.35 in	D	6 mm
D	0.24 inch	E	1.2 mm	E	0.05 in
F	3.2 mm	F	0.13 in		Smooth
	53 g	Ω	Conductive		