



## HS 8247

Long Flush Precision Cut 45°  
Angle Tapered Head Oblique  
Cutter 0.2 - 1 mm







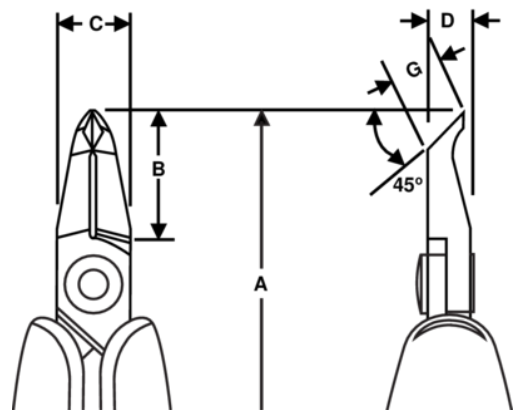

### PRODUCT DETAILS

- HS series oblique cutter 45° with tapered head
- ESD safe long foam handles with return spring
- Flush cut
- The stated cutting capacity is for copper wire
- Suitable for cutting copper
- High performance alloy steel
- Burnished finish
- Numerically controlled machine grinding ensures edge angle accuracy and contact, increasing tool reliability and consistency
- Precision induction hardened edges 63-65 HRC
- Screw joint minimises friction and maximises alignment of cutting edges
- Ideal for rework and close assembly needs



PRODUCT ATTRIBUTES

Product: **HS 8247**

	Angle 45°		L		Flush
	0.2-1.0 mm		0.01-0.04 in	<b>A</b>	149.8 mm
<b>A</b>	5.90 in	<b>B</b>	18 mm	<b>B</b>	0.71 in
<b>C</b>	10 mm	<b>C</b>	0.39 in	<b>D</b>	8 mm
<b>D</b>	0.31 inch	<b>G</b>	6.7 mm	<b>G</b>	0.26 in
	99 g		Dissipative		