



HS8211
Long Precision 20° Short Head
Oblique Cutters 0.2 mm-1.2 mm







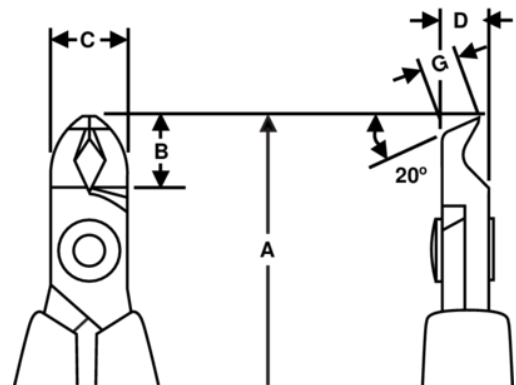

PRODUCT DETAILS

- HS series precision oblique cutter with short head
- ESD safe long foam handles with return spring
- Flush cut
- The stated cutting capacity is for copper wire
- Suitable for cutting copper
- High performance alloy steel
- Burnished finish
- Numerically controlled machine grinding ensures edge angle accuracy and contact, increasing tool reliability and consistency
- Precision induction hardened edges 63-65 HRC
- Screw joint minimises friction and maximises alignment of cutting edges
- Ideal for rework and close assembly needs



PRODUCT ATTRIBUTES

Product: **HS8211**

	Angle 20°		L		Flush
	0.2-1.2 mm		0.01-0.05 in	A	5.60 mm
A	142.3 in	B	9.5 mm	B	0.37 in
C	10 mm	C	0.39 in	D	8 mm
D	0.31 inch	G	4.1 mm	G	0.16 in
	91 g		Dissipative		