

HS8157

Long Flush Precision Cut Diagonal Cutter with Tapered & Relieved Head & ESD Safe Handle 0.2-1.25 mm







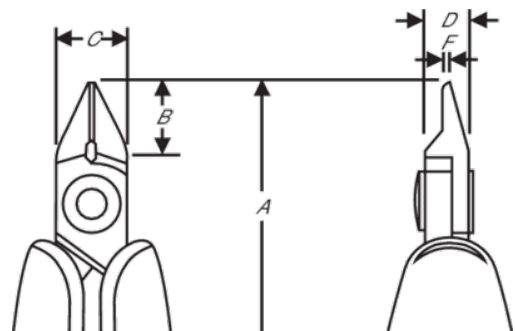

PRODUCT DETAILS

- HS series precision diagonal cutters with tapered & relieved head
- ESD safe long foam handles with return spring
- Micro-bevel, flush & ultra-flush cut
- The stated cutting capacity is for copper wire
- Suitable for cutting copper
- High performance alloy steel
- Burnished finish
- Numerically controlled machine grinding ensures edge angle accuracy and contact, increasing tool reliability and consistency
- Precision induction hardened edges 63-65 HRC
- Screw joint minimises friction and maximises alignment of cutting edges
- Ideal for wire harness work and standard printed circuit board assembly



PRODUCT ATTRIBUTES

Product: **HS8157**

	Tapered & Relieved		M		Flush
	0.2-1.25 mm		0.01-0.05 in	A	144.8 mm
A	5.70 in	B	12.5 mm	B	0.5 in
C	12.5 mm	C	0.49 in	D	6 mm
D	0.24 inch	F	1 mm	F	0.04 in
	97 g	Ω	Dissipative		