



RX8166

**ERGO™ Micro-Bevel® Precision
Cut Diagonal Cutter with Tapered
& Relieved Head 0.4-1.5 mm**







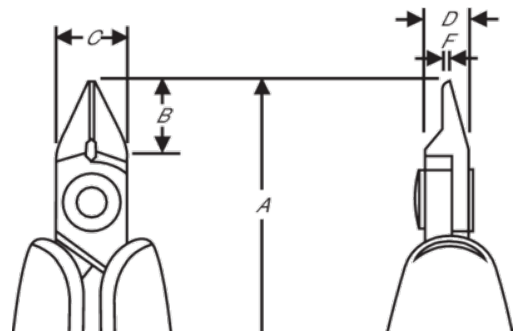

PRODUCT DETAILS

- Precision extra tapered & relieved head diagonal cutters developed according to the scientific ERGO™ process
- Extra Tapered & relieved head
- ERGO™ handles with two-component combination, thermoplastic surface, for comfortable grip, on tough polypropylene core for rigidity
- Flush & ultra-flush
- The cutting capacity that is given is for copper wire
- Cutting capacity: 0.1 mm-0.8 mm
- High performance alloyed steel
- Burnished finish
- Numerically controlled machine grinding guarantees edge angle accuracy & contact, increases the tool's reliability & consistency
- Precision induction-hardened edges 63-65 HRC
- Screw joint minimises friction & maximises alignment of cutting edges
- ESD safe handles in two-component synthetic material
- Bio spring limits the tension throughout the working cycle of the tool & can be adjusted to 3 different positions or removed
- Ideal for use in confined spaces & for rework thanks to the thinner tip head



PRODUCT ATTRIBUTES

Product: **RX8166**

	Tapered & Relieved		L		Micro-Bevel®
	0.4-1.5 mm		0.02-0.06 in	A	147 mm
A	5.80 in	B	16 mm	B	0.63 in
C	16 mm	C	0.63 in	D	8 mm
D	0.31 inch	F	1.6 mm	F	0.06 in
	139 g	Ω	Dissipative		