



HS8151

**Long Flush Precision Cut Diagonal
Cutter with Oval Head & ESD Safe
Handle 0.2-1.6 mm**







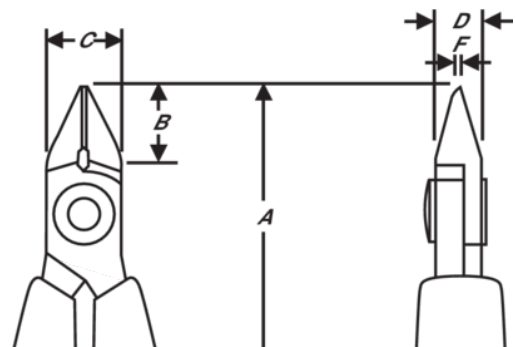



PRODUCT DETAILS

- HS series precision diagonal cutters
- ESD safe long foam handles with return spring
- Micro-bevel, flush & ultra-flush cut
- The stated cutting capacity is for copper wire
- Suitable for cutting copper
- High performance alloy steel
- Burnished finish
- Numerically controlled machine grinding ensures edge angle accuracy and contact, increasing tool reliability and consistency
- Precision induction hardened edges 63-65 HRC
- Screw joint minimises friction and maximises alignment of cutting edges
- Ideal for wire harness work and standard printed circuit board assembly



PRODUCT ATTRIBUTES

Product: **HS8151**

	Oval		M		Flush
	0.2-1.6 mm		0.01-0.06 in		0.2-0.8 mm
	0.01-0.03 in	A	144.8 mm	A	5.70 in
B	12.5 mm	B	0.5 in	C	12.5 mm
C	0.49 in	D	6 mm	D	0.24 inch
F	1.2 mm	F	0.05 in		98 g
Ω	Dissipative				