



**7280**

**Flush Precision Cut 45° Reverse angle & HS Long 45° Reverse Angle Cutters 0.2 mm-08 mm**







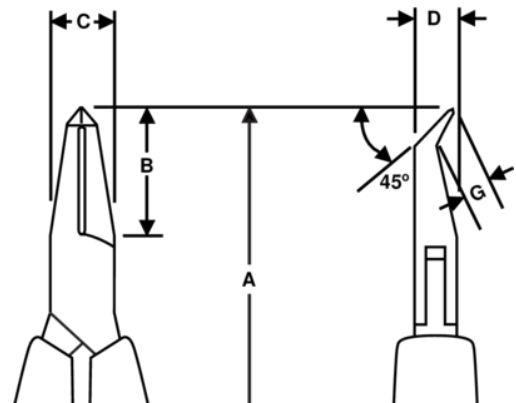

**PRODUCT DETAILS**

- Supreme series & reverse angle oblique cutter
- ESD safe mono-material handles with return spring
- Flush cut
- The cutting capacity given is for copper wire
- Suitable for cutting Cu
- High performance alloyed steel
- Polished finish
- Numerically controlled machine grinding guarantees edge angle accuracy & contact, increases the tools reliability & consistency
- Precision induction hardened edges 58-60 HRC
- Screw joint that minimizes friction & maximizes alignment of cutting edges
- Ideal for use in confined spaces



PRODUCT ATTRIBUTES

Product: **7280**

	Angle 45°		S		Flush
	0.2-08 mm		0.01-0.03 in	<b>A</b>	120 mm
<b>A</b>	4.72 in	<b>B</b>	20 mm	<b>B</b>	0.79 in
<b>C</b>	9 mm	<b>C</b>	0.35 in	<b>D</b>	6 mm
<b>D</b>	0.24 inch	<b>F</b>	3.5 mm	<b>F</b>	0.14 in
	56 g	<b>Ω</b>	Dissipative		