



8247

**Flush Precision Cut 45° Angle  
Head Oblique Cutter 0.2 -1 mm**







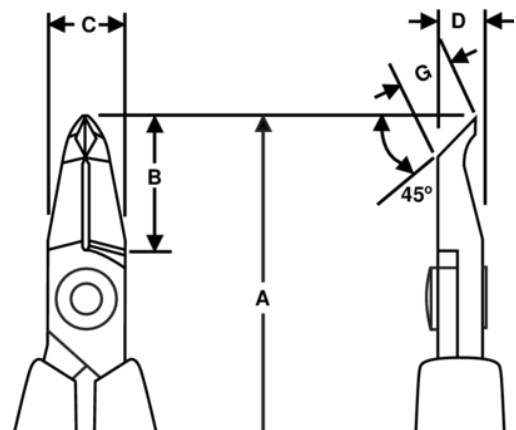

PRODUCT DETAILS

- 80 series oblique cutter 45° with Tapered Head
- ESD safe mono-material handles with return spring
- Flush cut
- The cutting capacity given is for copper wire
- Suitable for cutting Cu
- High performance alloyed steel
- Burnished finish
- Numerically controlled machine grinding guarantees edge angle accuracy & contact, increases the tools reliability & consistency
- Precision induction hardened edges 63-65 HRC
- Screw joint that minimizes friction & maximizes alignment of cutting edges
- Ideal for rework & close assembly needs
- CO standard handle shape in conductive material



PRODUCT ATTRIBUTES

Product: **8247**

	Angle 45°		S		Flush
	0.2-1.0 mm		0.01-0.04 in	<b>A</b>	117.5 mm
<b>A</b>	4.63 in	<b>B</b>	18 mm	<b>B</b>	0.71 in
<b>C</b>	10 mm	<b>C</b>	0.39 in	<b>D</b>	6 mm
<b>D</b>	0.24 inch	<b>G</b>	6.7 mm	<b>G</b>	0.26 in
	51 g		Dissipative		