



8211

**Short Flush Precision Cut 20°
Angle Head Oblique Cutter 0.2 -1.2
mm**



PRODUCT DETAILS





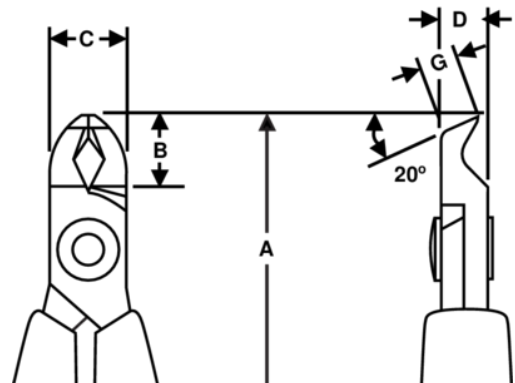

- 80 Series precision oblique cutter with Short Head
- ESD safe mono-material handles with return spring
- Flush cut
- The cutting capacity given is for copper wire
- Suitable for cutting Cu
- High performance alloyed steel

- Phosphate finish
- Numerically controlled machine grinding guarantees edge angle accuracy & contact, increases the tools reliability & consistency
- Precision induction hardened edges 63-65 HRC
- Screw joint that minimizes friction & maximizes alignment of cutting edges
- Ideal for rework & close assembly needs
- CO standard handle shape in conductive material



PRODUCT ATTRIBUTES

Product: **8211**

	Angle 20°		S	A	110.0 mm
A	4.33 in	B	9,5 mm	B	0,37 in
C	10 mm	C	0.39 in	D	6 mm
D	0,24 inch	G	4,1 mm	G	0,16 in
	0.2-1.2 mm		0.01-0.05 in		Flush
	43 g	Ω	Dissipative		