



RX 8247

ERGO™ Long Flush Precision Cut 45° Angle Tapered Head Oblique Cutter 0.2 -1 mm







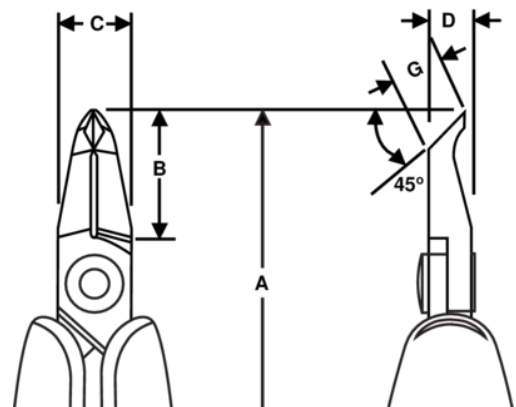

PRODUCT DETAILS

- Precision oblique cutters 45° long head developed according to the scientific ERGO™ process
- ERGO™ handles with two-component combination, thermoplastic surface, for comfortable grip, on tough polypropylene core for rigidity
- Flush cut
- The cutting capacity that is given is for copper wire
- Cutting capacity: 0.2 mm to 1 mm Cu
- High performance alloyed steel
- Burnished finish
- Numerically controlled machine grinding guarantees edge angle accuracy & contact, increases the tool's reliability & consistency
- Precision induction-hardened edges 63-65 HRC
- Screw joint minimises friction & maximises alignment of cutting edges
- ESD safe handles in two-component synthetic material
- Bio spring limits the tension throughout the working cycle of the tool & can be adjusted to 3 different positions or removed
- Ideal for rework & close assembly needs



PRODUCT ATTRIBUTES

Product: **RX 8247**

	Angle 45°		S		Flush
	0.2-1.0 mm		0.01-0.04 in	A	143 mm
A	5.63 in	B	18 mm	B	0.71 in
C	10 mm	C	0.39 in	D	6 mm
D	0.24 inch	G	6.7 mm	G	0.26 in
	72 g		Dissipative		