



7590-7591

Round Nose Tipped Pliers with Synthetic Handle





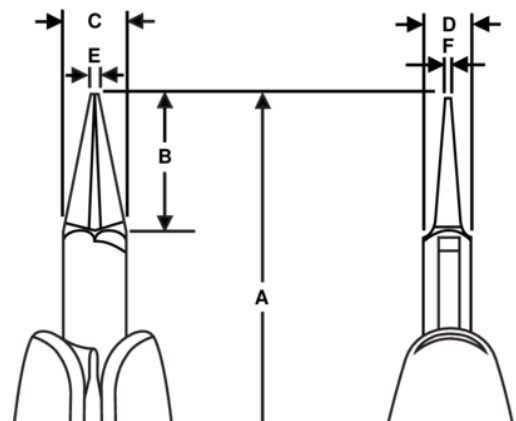

PRODUCT DETAILS

- Supreme series round nose pliers
- Round jaws taper from 7 mm to 1.0 mm at the tip
- ESD safe mono-material handles with return spring
- High performance alloyed steel
- Polished finish
- Numerically controlled machine grinding guarantees accuracy & increases the tools reliability & consistency
- Tough hardened 42-46 HRC
- Screw joint that minimizes friction & maximizes jaw alignment
- Round jaws with no sharp edges
- 7591 with long tip







PRODUCT ATTRIBUTES





Product: 7590

	Round Nose		S	A	146.5 mm
A	5.77 in	B	20 mm	B	0,79 in
C	9 mm	C	0.35 in	D	6 mm
D	0,24 inch	E	1,4 mm	E	0,055 in
F	0,7 mm	F	0,027 in		Smooth
	69 g	Ω	Dissipative		

Product: 7590 CO

	Round Nose		S	A	146.5 mm
A	5.77 in	B	20 mm	B	0,79 in
C	9 mm	C	0.35 in	D	6 mm
D	0,24 inch	E	1,4 mm	E	0,055 in
F	0,7 mm	F	0,027 in		Smooth
	54 g	Ω	Conductive		

Product: 7591

	Round Nose		M	A	165 mm
A	6.5 in	B	38,5 mm	B	1,51 in
C	9 mm	C	0.35 in	D	6,7 mm
D	0,24 inch	E	1,4 mm	E	0,055 in
F	0,7 mm	F	0,027 in		Smooth
	75 g	Ω	Dissipative		