



HS7285

**Long Flush Precision Cut 45°
Angle Oblique Cutter 0.2 -1 mm**







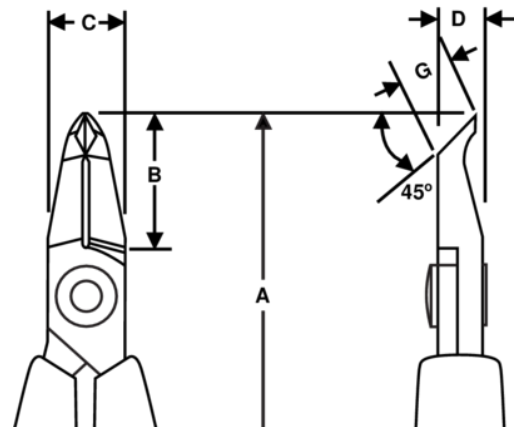

PRODUCT DETAILS

- HS series 45° oblique cutter
- ESD safe long foam handles with return spring
- Flush cut
- The stated cutting capacity is for copper wire
- Suitable for cutting copper
- High performance alloy steel
- Polished finish
- Numerically controlled machine grinding ensures edge angle accuracy and contact, increasing tool reliability and consistency
- Precision induction hardened edges 63-65 HRC
- Screw joint minimises friction and maximises alignment of cutting edges
- Ideal for rework and close assembly needs



PRODUCT ATTRIBUTES

Product: **HS7285**

	Angle 45°		S		Flush
	0.2-1.0 mm		0.01-0.04 in	A	152.3 mm
A	5.99 in	B	20 mm	B	0.79 in
C	9 mm	C	0.35 in	D	6 mm
D	0.24 inch	G	6 mm	G	0.26 in
	103 g		Dissipative		