



## HS 7890-HS 7891

### Long Snipe Nose Pliers with Dual-Component Synthetic Handle





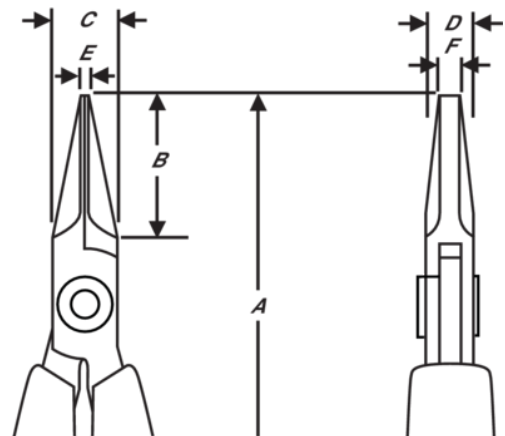

#### PRODUCT DETAILS

- HS series snipe nose pliers
- ESD safe long foam handles with return spring
- High performance alloy steel
- Polished finish
- Numerically controlled machine grinding ensures edge angle accuracy and contact, increasing tool reliability and consistency
- Tough, hardened 42-46 HRC
- Screw joint minimises friction and maximises jaw alignment
- 32 mm jaws with radiused edges







PRODUCT ATTRIBUTES

Product: **HS 7890**

	Chain Nose		M	<b>A</b>	164.3 mm
<b>A</b>	6.47 in	<b>B</b>	32 mm	<b>B</b>	1.26 in
<b>C</b>	9 mm	<b>C</b>	0.35 in	<b>D</b>	6 mm
<b>D</b>	0.24 inch	<b>E</b>	1.2 mm	<b>E</b>	0.05 in
<b>F</b>	0.8 mm	<b>F</b>	0.03 in		Smooth
	105 g	<b>Ω</b>	Dissipative		

Product: **HS 7891**

	Chain Nose		M	<b>A</b>	164.3 mm
<b>A</b>	6.47 in	<b>B</b>	32 mm	<b>B</b>	1.26 in
<b>C</b>	9 mm	<b>C</b>	0.35 in	<b>D</b>	6 mm
<b>D</b>	0.24 inch	<b>E</b>	1.2 mm	<b>E</b>	0.05 in
<b>F</b>	0.8 mm	<b>F</b>	0.03 in		Serrated
	106 g	<b>Ω</b>	Dissipative		