



HS 7280

Long Precision 45° Reverse angle
& HS Long 45° Reverse Angle
Cutters 0.2 mm-08 mm







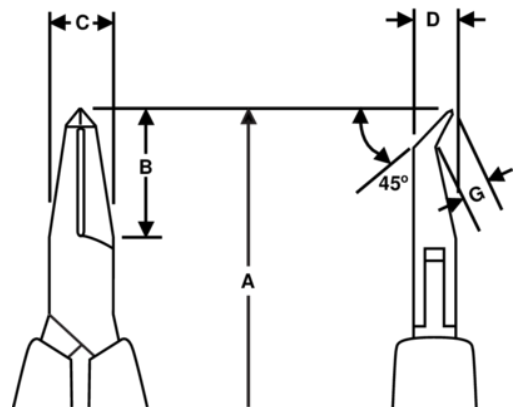

PRODUCT DETAILS

- HS series and reverse angle oblique cutter
- ESD safe long foam handles with return spring
- Flush cut
- The stated cutting capacity is for copper wire
- Suitable for cutting copper
- High performance alloy steel
- Polished finish
- Numerically controlled machine grinding ensures edge angle accuracy and contact, increasing tool reliability and consistency
- Precision induction hardened edges 63-65 HRC
- Screw joint minimises friction and maximises alignment of cutting edges
- Ideal for use in confined spaces



PRODUCT ATTRIBUTES

Product: **HS7280**

	Angle 45°		S		Flush
	0.2-0.8 mm		0.01-0.03 in	A	150.3 mm
A	5.91 in	B	18 mm	B	0.71 in
C	9 mm	C	0.35 in	D	6 mm
D	0.24 inch	G	3.5 mm	G	0.14 in
	102 g	Ω	Dissipative		