



RX 8130-RX 8162 ERGO™ Precision Diagonal Cutters with Oval Head







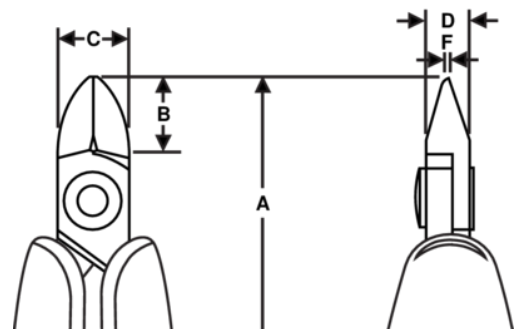

PRODUCT DETAILS

- Precision oval head diagonal cutters developed according to the scientific ERGO™ process, Oval head
- ERGO™ handles with two-component combination, thermoplastic surface, for comfortable grip, on tough polypropylene core for rigidity
- Micro-bevel, flush & ultra-cut
- The cutting capacity that is given is for copper wire
- Cutting capacity: 0.1 mm-0.8 mm to 0.4 mm-2 mm
- High performance alloyed steel
- Burnished finish
- Numerically controlled machine grinding guarantees edge angle accuracy & contact, increases the tool's reliability & consistency
- Precision induction-hardened edges 63-65 HRC
- Screw joint minimises friction & maximises alignment of cutting edges
- ESD safe handles in two-component synthetic material
- Bio spring limits the tension throughout the working cycle of the tool & can be adjusted to 3 different positions or removed
- Ideal for wire harness work & standard printed circuit board assembly









PRODUCT ATTRIBUTES







Product: RX 8130

	Oval		XS		Micro-Bevel®
	0.2-1.0 mm		0.00 - 0.04 in		
		A	133.5 mm	A	5.25 in
B	8.5 mm	B	0.33 in	C	8 mm
C	0.31 in	D	5 mm	D	0.2 inch
F	0.8 mm	F	0.03 in	g	68 g
Ω	Dissipative				







Product: RX 8131

	Oval		XS		Flush
	0.1-1.0 mm		0.00 - 0.04 in		
		A	133.5 mm	A	5.25 in
B	8.5 mm	B	0.33 in	C	8 mm
C	0.31 in	D	5 mm	D	0.2 inch
F	0.8 mm	F	0.03 in	g	68 g
Ω	Dissipative				







Product: RX 8132

	Oval		XS		Ultra-Flush®
	0.1-0.8 mm		0.00-0.03 in		
		A	133.5 mm	A	5.25 in
B	8.5 mm	B	0.33 in	C	8 mm
C	0.31 in	D	5 mm	D	0.2 inch
F	0.8 mm	F	0.03 in	g	68 g
Ω	Dissipative				







Product: RX 8140

	Oval		S		Micro-Bevel®
	0.2-1.25 mm		0.00-0.05 in		0.2-0.5 mm
	0.01-0.02 in	A	135.5 mm	A	5.33 in
B	10.5 mm	B	0.41 in	C	10 mm
C	0.39 in	D	6 mm	D	0.24 inch
F	0.8 mm	F	0.03 in	g	70 g
Ω	Dissipative				







Product: RX 8141

	Oval		S		Flush
	0.1-1.25 mm		0.00-0.05 in		0.2-0.5 mm
	0.01-0.02 in	A	135.5 mm	A	5.33 in
B	10.5 mm	B	0.41 in	C	10 mm
C	0.39 in	D	6 mm	D	0.24 inch
F	0.8 mm	F	0.03 in	g	70 g
Ω	Dissipative				







Product: RX 8142

	Oval		S		Ultra-Flush®
	0.1-1.0 mm		0.00-0.04 in		
		A	135.5 mm	A	5.33 in
B	10.5 mm	B	0.41 in	C	10 mm
C	0.39 in	D	6 mm	D	0.24 inch
F	0.8 mm	F	0.03 in	g	70 g
Ω	Dissipative				







Product: RX 8150

	Oval		M		Micro-Bevel [®]
	0.3-1.6 mm		0.01-0.06 in		0.2-0.8 mm
	0.01-0.03 in	A	138 mm	A	5.43 in
B	13 mm	B	0.51 in	C	12.5 mm
C	0.49 in	D	6 mm	D	0.24 inch
F	1.2 mm	F	0.05 in	g	73 g
Ω	Dissipative				







Product: RX 8151

	Oval		M		Flush
	0.2-1.6 mm		0.00-0.06 in		0.2-0.8 mm
	0.01-0.03 in	A	138 mm	A	5.43 in
B	13 mm	B	0.51 in	C	12.5 mm
C	0.49 in	D	6 mm	D	0.24 inch
F	1.2 mm	F	0.05 in	g	73 g
Ω	Dissipative				







Product: RX 8152

	Oval		M		Ultra-Flush [®]
	0.2-1.25 mm		0.00-0.05 in		
		A	138 mm	A	5.43 in
B	13 mm	B	0.51 in	C	12.5 mm
C	0.49 in	D	6 mm	D	0.24 inch
F	1.2 mm	F	0.05 in	g	73 g
Ω	Dissipative				







Product: RX 8160

	Oval		L		Micro-Bevel [®]
	0.4-2.0 mm		0.02 - 0.08 in		0.3-0.8 mm
	0.01-0.03 in	A	147 mm	A	5.80 in
B	16 mm	B	0.63 in	C	16 mm
C	0.63 in	D	8 mm	D	0.31 inch
F	1.6 mm	F	0.06 in	g	97 g
Ω	Dissipative				

Product: RX 8161

	Oval		L		Flush
	0.3-2.0 mm		0.01 - 0.08 in		0.3-0.8 mm
	0.01-0.03 in	A	147 mm	A	5.80 in
B	16 mm	B	0.63 in	C	16 mm
C	0.63 in	D	8 mm	D	0.31 inch
F	1.6 mm	F	0.06 in	g	97 g
Ω	Dissipative				

Product: RX 8162

	Oval		L		Ultra-Flush [®]
	0.3-1.6 mm		0.01 - 0.06 in		
		A	147 mm	A	5.80 in
B	16 mm	B	0.63 in	C	16 mm
C	0.63 in	D	8 mm	D	0.31 inch
F	1.6 mm	F	0.06 in	g	97 g
Ω	Dissipative				