



HS6000 Multipurpose Shear with Non-Slip Grips







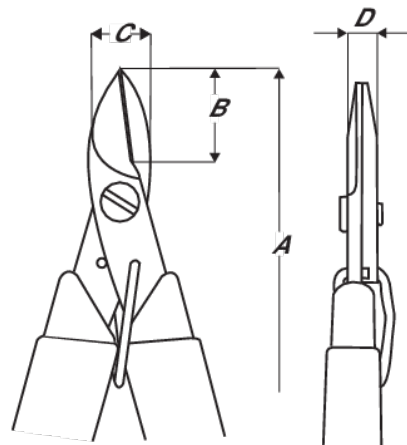

PRODUCT DETAILS

- Kevlar cutter
- Designed to cut tough Kevlar elements used in fibre optic & other types of cables
- High carbon steel blades with a hardness of 57-59 HRC
- Serrations on one edge to prevent the material being cut from sliding away
- Precision screw joint minimises friction & maximises alignment of cutting edges
- User-friendly while optimising durability & precision
- Fits comfortably in either hand
- ESD safe non-slip grips provide cushioning & secure grasp
- Ideal for many other applications such as cutting insulation, cables, ties & corded material of all types









PRODUCT ATTRIBUTES

Product: HS6000

	Serrated-Jaws		L		Flush
	Kevlar	A	145 mm	A	5.7 in
B	29 mm	B	1.1 in	C	12.7 mm
C	0.5 in	D	6.4 mm	D	0.2 inch
	Serrated		88 g		Dissipative

Product: HS6001

	Smooth-Jaws		L		Flush
	Kevlar	A	145 mm	A	5.7 in
B	29 mm	B	1.1 in	C	12.7 mm
C	0.5 in	D	6.4 mm	D	0.2 inch
	Smooth		88 g		Dissipative