



RX 8237
ERGO™ Precision Micro Tip
Cutters 144 mm







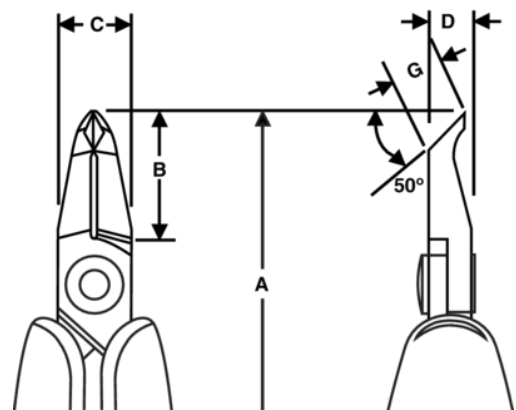

PRODUCT DETAILS

- Precision micro tip cutters developed according to the scientific ERGO™ process
- ESD safe ERGO™ handles with two-component combination, thermoplastic surface for comfortable grip, on tough polypropylene core for rigidity
- Flush cut
- Cutting capacity: 0.1 mm to 0.65 mm Cu
- High-performance alloyed steel
- Burnished finish
- Numerically controlled machine grinding guarantees edge angle accuracy & contact, increases the tool's reliability & consistency
- Precision induction-hardened edges 63-65 HRC
- Screw joint minimises friction & maximises alignment of cutting edges
- Bio spring limits the tension throughout the working cycle of the tool & can be adjusted to 3 different positions or removed
- Ideal rework & close fine pitch applications



PRODUCT ATTRIBUTES

Product: **RX8237A**

	Angle 50°		XS		Flush
	0.1-0.5 mm		0.004-0.02 in	A	144 mm
A	5.6 in	B	17.4 mm	B	0.69 in
C	10.6 mm	C	0.41 in	D	7 mm
D	0.27 inch	G	4.1 mm	G	0.16 in
	65 g	Ω	Dissipative		