



HS 8248

**Long Ultra-Flush® Precision Cut
45° Angle Tapered & Relieved
Head Oblique Cutter with
Conductive Material Handle 0.2
-0.8 mm**







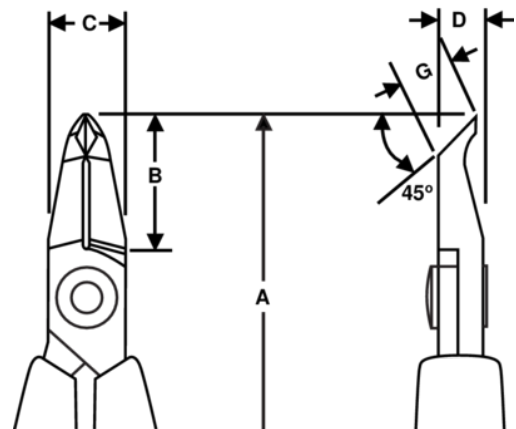

PRODUCT DETAILS

- HS series precision oblique cutter 45° with long & relieved head
- ESD safe long foam handles with return spring
- Flush cut
- The stated cutting capacity is for copper wire
- Suitable for cutting copper
- High performance alloy steel
- Burnished finish
- Numerically controlled machine grinding ensures edge angle accuracy and contact, increasing tool reliability and consistency
- Precision induction hardened edges 63-65 HRC
- Screw joint minimises friction and maximises alignment of cutting edges
- Ideal for rework and close assembly needs



PRODUCT ATTRIBUTES

Product: **HS 8248**

	Tapered & Relieved		L		Flush
	0.2-0.8 mm		0.01-0.03 in	A	149.8 mm
A	5.90 in	B	18 mm	B	0.71 in
C	10 mm	C	0.39 in	D	8 mm
D	0.31 inch	G	6.7 mm	G	0.26 in
	99 g	Ω	Dissipative		