



## HS8156

**Long Micro-Bevel® Precision Cut  
Diagonal Cutter with Tapered &  
Relieved Head & ESD Safe Handle  
0.3-1.25 mm**







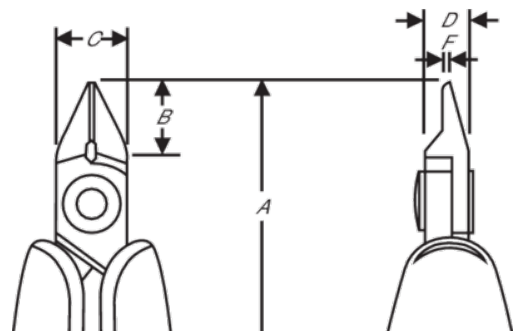

### PRODUCT DETAILS

- HS series precision diagonal cutters with tapered & relieved head
- ESD safe long foam handles with return spring
- Micro-bevel, flush & ultra-flush cut
- The stated cutting capacity is for copper wire
- Suitable for cutting copper
- High performance alloy steel
- Burnished finish
- Numerically controlled machine grinding ensures edge angle accuracy and contact, increasing tool reliability and consistency
- Precision induction hardened edges 63-65 HRC
- Screw joint minimises friction and maximises alignment of cutting edges
- Ideal for wire harness work and standard printed circuit board assembly



PRODUCT ATTRIBUTES

Product: **HS8156**

|   |                    |   |              |   |              |
|---|--------------------|---|--------------|---|--------------|
|  | Tapered & Relieved |  | M            |  | Micro-Bevel® |
|  | 0.3-1.25 mm        |  | 0.01-0.05 in | <b>A</b>  | 144.8 mm     |
| <b>A</b>  | 5.70 in            | <b>B</b>  | 12.5 mm      | <b>B</b>  | 0.5 in       |
| <b>C</b>  | 12.5 mm            | <b>C</b>  | 0.49 in      | <b>D</b>  | 6 mm         |
| <b>D</b>  | 0.24 inch          | <b>F</b>  | 1 mm         | <b>F</b>  | 0.04 in      |
|  | 97 g               |  | Dissipative  |   |              |