



HS 8148

**Long Ultra-Flush® Precision Cut
Diagonal Cutter with Tapered &
Relieved Head & ESD Safe Handle
0.1-0.8 mm**







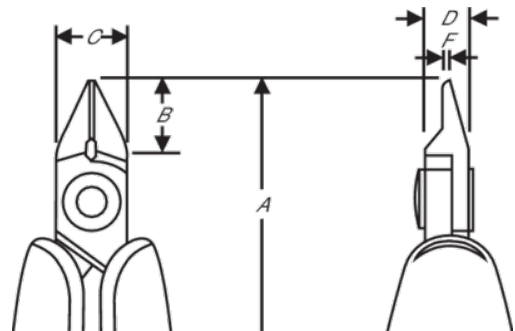

PRODUCT DETAILS

- HS series precision diagonal cutters with tapered & relieved head
- ESD safe long foam handles with return spring
- Micro-bevel, flush & ultra-flush cut
- The stated cutting capacity is for copper wire
- Suitable for cutting copper
- High performance alloy steel
- Burnished finish
- Numerically controlled machine grinding ensures edge angle accuracy and contact, increasing tool reliability and consistency
- Precision induction hardened edges 63-65 HRC
- Screw joint minimises friction and maximises alignment of cutting edges
- Ideal for wire harness work and standard printed circuit board assembly



PRODUCT ATTRIBUTES

Product: **HS 8148**

	Tapered & Relieved		S		Ultra-Flush®
	0.1–0.8 mm		0.01–0.03 in	A	5.60 mm
A	142.3 in	B	10 mm	B	0.39 in
C	10 mm	C	0.39 in	D	6 mm
D	0.24 inch	F	0.8 mm	F	0.03 in
	90 g	Ω	Dissipative		