

RX 8137

**ERGO™ Flush Precision Cut
Diagonal Cutter with Tapered &
Relieved Head & ESD Safe Handle
0.1-0.8 mm**







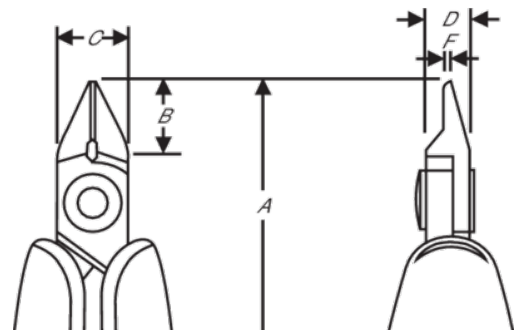

PRODUCT DETAILS

- Precision extra tapered & relieved head diagonal cutters developed according to the scientific ERGO™ process
- Extra Tapered & relieved head
- ERGO™ handles with two-component combination, thermoplastic surface, for comfortable grip, on tough polypropylene core for rigidity
- Flush & ultra-flush
- The cutting capacity that is given is for copper wire
- Cutting capacity: 0.1 mm-0.8 mm
- High performance alloyed steel
- Burnished finish
- Numerically controlled machine grinding guarantees edge angle accuracy & contact, increases the tool's reliability & consistency
- Precision induction-hardened edges 63-65 HRC
- Screw joint minimises friction & maximises alignment of cutting edges
- ESD safe handles in two-component synthetic material
- Bio spring limits the tension throughout the working cycle of the tool & can be adjusted to 3 different positions or removed
- Ideal for use in confined spaces & for rework thanks to the thinner tip head



PRODUCT ATTRIBUTES

Product: **RX 8137**

	Tapered & Relieved		XS		Flush
	0.1-0.8 mm		0.004-0.03 in	A	108 mm
A	4.25 in	B	8 mm	B	0.31 in
C	8 mm	C	0.31 in	D	5 mm
D	0.2 inch	F	0.8 mm	F	0.03 in
	66 g	Ω	Dissipative		