



RX8150M2

ERGO™ Precision Micro Cut Diagonal Cutter with Oval Head & ESD Safe Handle for hard materials







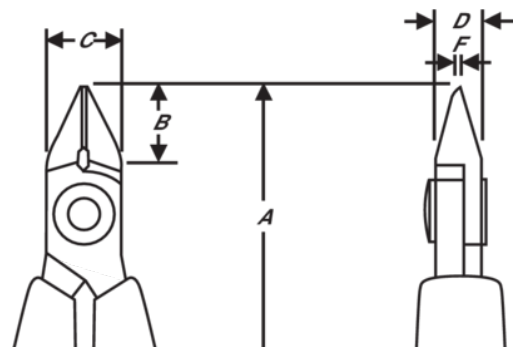



PRODUCT DETAILS

- Precision oval head diagonal cutters developed according to the scientific ERGO™ process, Oval head
- Designed to cut hard wires, stents, guidewires and monofilar or multifilar catheter coils
- ERGO™ handles with two-component combination and thermoplastic surface for comfortable grip, on tough polypropylene core for rigidity
- Micro-bevel, flush & ultra-flush cut
- The stated cutting capacity is for copper wire
- Cutting capacity: 0.1-0.8 mm to 0.4-2 mm
- High performance alloy steel
- Burnished finish
- Numerically controlled machine grinding ensures edge angle accuracy and contact, increasing tool reliability and consistency
- Precision induction-hardened edges 63-65 HRC
- Screw joint minimises friction and maximises alignment of cutting edges
- ESD safe handles in two-component synthetic material
- Bio spring limits tension through the working cycle of the tool and can be adjusted to 3 different positions or removed
- Ideal for wire harness work and standard printed circuit board assembly



PRODUCT ATTRIBUTES

Product: **RX8150M2**

	Oval		M		Micro-Bevel®
	0.4-2.0 mm		0.01-0.06 in		0.2-0.8 mm
	0.01-0.03 in	A	138 mm	A	5.30 in
B	13 mm	B	0.51 in	C	12.5 mm
C	0.49 in	D	6 mm	D	0.24 inch
E	1.2 mm	E	0.05 in		70 g