



HS 8130

Long Micro-Bevel® Precision Cut Diagonal Cutter with Oval Head & ESD Safe Handle 0.2-1 mm







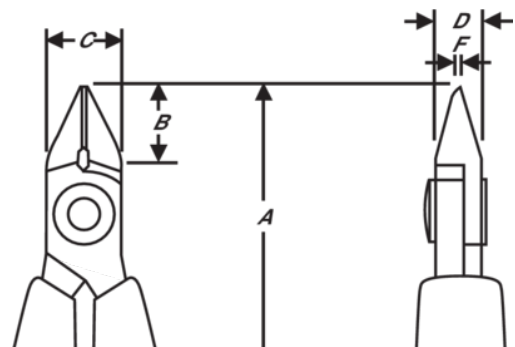



PRODUCT DETAILS

- HS series precision diagonal cutters
- ESD safe long foam handles with return spring
- Micro-bevel, flush & ultra-flush cut
- The stated cutting capacity is for copper wire
- Suitable for cutting copper
- High performance alloy steel
- Burnished finish
- Numerically controlled machine grinding ensures edge angle accuracy and contact, increasing tool reliability and consistency
- Precision induction hardened edges 63-65 HRC
- Screw joint minimises friction and maximises alignment of cutting edges
- Ideal for wire harness work and standard printed circuit board assembly



PRODUCT ATTRIBUTES

Product: **HS 8130**

| | | | | | |
|---|-------------|---|--------------|---|--------------|
|  | Oval |  | XS |  | Micro-Bevel® |
|  | 0.2-1.25 mm |  | 0.01-0.05 in |  | |
|  | | A | 140.3 mm | A | 5.52 in |
| B | 8 mm | B | 0.31 in | C | 8 mm |
| C | 0.31 in | D | 5 mm | D | 0.2 inch |
| F | 0.8 mm | F | 0.03 in |  | 91 g |
| Ω | Dissipative | | | | |