



8148 CO

**Ultra-Flush® Precision Cut
Diagonal Cutter with Tapered &
Relieved Head & ESD Safe
Conductive Material Handle 0.1-0.8
mm**







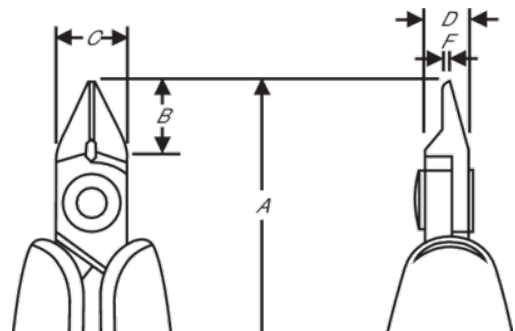

PRODUCT DETAILS

- 80 series precision diagonal cutters with tapered & relieved head
- ESD safe mono-material handles with return spring
- Micro-bevel, flush & ultra-flush cut
- The stated cutting capacity is for copper wire
- Suitable for cutting copper
- High performance alloy steel
- Burnished finish
- Numerically controlled machine grinding ensures edge angle accuracy and contact, increasing tool reliability and consistency
- Precision induction hardened edges 63-65 HRC
- Screw joint minimises friction and maximises alignment of cutting edges
- Ideal for use in confined spaces and for rework



PRODUCT ATTRIBUTES

Product: **8148 CO**

| | | | | | |
|---|--------------------|---|--------------|---|--------------|
|  | Tapered & Relieved |  | S |  | Ultra-Flush® |
|  | 0.1-0.8 mm |  | 0.00-0.03 in | A | 110 mm |
| A | 4.33 in | B | 10 mm | B | 0.39 in |
| C | 10 mm | C | 0.39 in | D | 6 mm |
| D | 0.24 inch | F | 0.8 mm | F | 0.03 in |
|  | 45 g | Ω | Conductive | | |