



RX 8131
ERGO™ Flush Precision Cut
Diagonal Cutter with Oval Head
0.1-1 mm







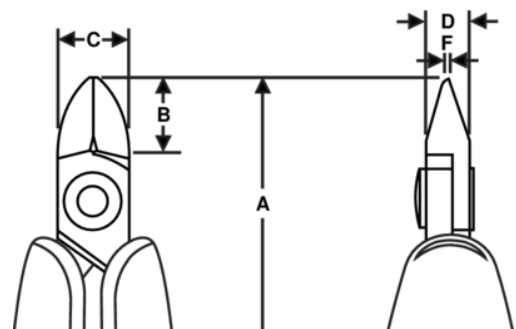



PRODUCT DETAILS

- Precision oval head diagonal cutters developed according to the scientific ERGO™ process, Oval head
- ERGO™ handles with two-component combination, thermoplastic surface, for comfortable grip, on tough polypropylene core for rigidity
- Micro-bevel, flush & ultra-cut
- The cutting capacity that is given is for copper wire
- Cutting capacity: 0.1 mm-0.8 mm to 0.4 mm-2 mm
- High performance alloyed steel
- Burnished finish
- Numerically controlled machine grinding guarantees edge angle accuracy & contact, increases the tool's reliability & consistency
- Precision induction-hardened edges 63-65 HRC
- Screw joint minimises friction & maximises alignment of cutting edges
- ESD safe handles in two-component synthetic material
- Bio spring limits the tension throughout the working cycle of the tool & can be adjusted to 3 different positions or removed
- Ideal for wire harness work & standard printed circuit board assembly



PRODUCT ATTRIBUTES

Product: **RX 8131**

	Oval		XS		Flush
	0.1-1.0 mm		0.00 - 0.04 in		
		A	133.5 mm	A	5.25 in
B	8.5 mm	B	0.33 in	C	8 mm
C	0.31 in	D	5 mm	D	0.2 inch
F	0.8 mm	F	0.03 in		68 g
Ω	Dissipative				