

8247 CO

**Flush Precision Cut 45° Angle
Tapered Head Oblique Cutter with
Conductive Material Handle 0.2 - 1
mm**







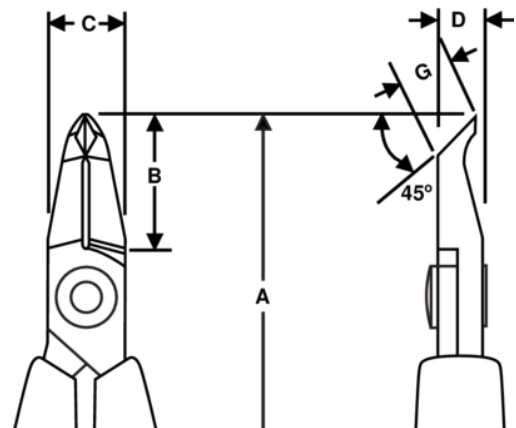

PRODUCT DETAILS

- 80 series oblique cutter 45° with Tapered Head
- ESD safe mono-material handles with return spring
- Flush cut
- The cutting capacity given is for copper wire
- Suitable for cutting Cu
- High performance alloyed steel
- Burnished finish
- Numerically controlled machine grinding guarantees edge angle accuracy & contact, increases the tools reliability & consistency
- Precision induction hardened edges 63-65 HRC
- Screw joint that minimizes friction & maximizes alignment of cutting edges
- Ideal for rework & close assembly needs
- CO standard handle shape in conductive material



PRODUCT ATTRIBUTES

Product: **8247 CO**

	Angle 45°		S		Flush
	0.2-1.0 mm		0.01-0.04 in	A	117.5 mm
A	4.63 in	B	18 mm	B	0.71 in
C	10 mm	C	0.39 in	D	6 mm
D	0.24 inch	G	6.7 mm	G	0.26 in
	51 g		Conductive		