



HS6001
Multipurpose Shear with Non-Slip Grip & Serrated Jaws 145 mm



PRODUCT DETAILS





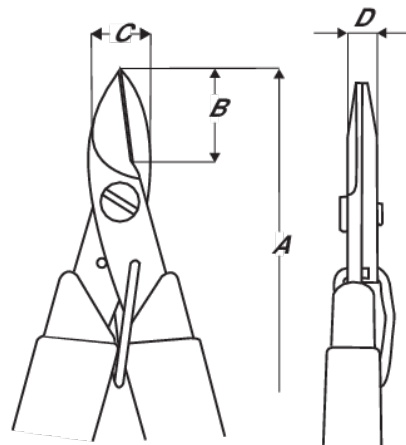
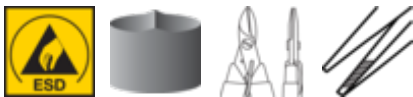

- Kevlar cutter
- Designed to cut tough Kevlar elements used in fibre optic & other types of cables
- High carbon steel blades with a hardness of 57-59 HRC
- Serrations on one edge to prevent the material being cut from sliding away
- Precision screw joint minimises friction & maximises alignment of cutting edges

- User-friendly while optimising durability & precision
- Fits comfortably in either hand
- ESD safe non-slip grips provide cushioning & secure grasp
- Ideal for many other applications such as cutting insulation, cables, ties & corded material of all types



PRODUCT ATTRIBUTES

Product: **HS6001**

	Smooth-Jaws		L		Flush
	Kevlar	A	145 mm	A	5.7 in
B	29 mm	B	1.1 in	C	12.7 mm
C	0.5 in	D	6.4 mm	D	0.2 inch
	Smooth		88 g	Ω	Dissipative