



HS8149

Long Precision Diagonal Tip Cutter with ESD Safe Handle 0.1-0.6 mm







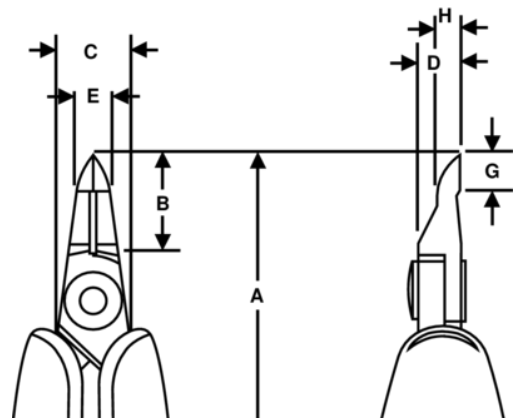

PRODUCT DETAILS

- HS series precision diagonal cutters with tip cut
- ESD safe long foam handles with return spring
- Flush cut
- The stated cutting capacity is for copper wire
- Suitable for cutting copper
- High performance alloy steel
- Burnished finish
- Numerically controlled machine grinding ensures edge angle accuracy and contact, increasing tool reliability and consistency
- Precision induction hardened edges 63-65 HRC
- Screw joint minimises friction and maximises alignment of cutting edges
- Ideal for use with multi-lead components and for rework



PRODUCT ATTRIBUTES

Product: **HS8149**

	Tip Cutter		S		Flush
	0.1-0.6 mm		0.01-0.02 in	A	146.3 mm
A	5.76 in	B	14 mm	B	0.55 in
C	5 mm	C	0.23 in	D	6 mm
D	0.24 inch	E	5 mm	E	0.23 in
G	5 mm	G	0.23 in	H	3.2 mm
H	0.13 in		90 g	Ω	Dissipative