



**HS7285**

**Long Flush Precision Cut 45°  
Angle Oblique Cutter 0.2 -1 mm**







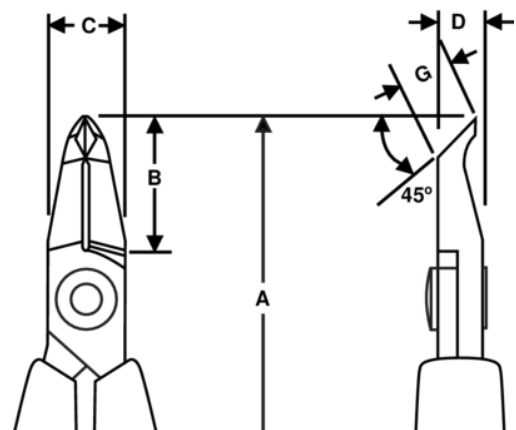

## PRODUCT DETAILS

- HS series 45° oblique cutter
- ESD safe long foam handles with return spring
- Flush cut
- The stated cutting capacity is for copper wire
- Suitable for cutting copper
- High performance alloy steel
- Polished finish
- Numerically controlled machine grinding ensures edge angle accuracy and contact, increasing tool reliability and consistency
- Precision induction hardened edges 63-65 HRC
- Screw joint minimises friction and maximises alignment of cutting edges
- Ideal for rework and close assembly needs



PRODUCT ATTRIBUTES

Product: **HS7285**

	Angle 45°		S		Flush
	0.2-1.0 mm		0.01-0.04 in	<b>A</b>	152.3 mm
<b>A</b>	5.99 in	<b>B</b>	20 mm	<b>B</b>	0.79 in
<b>C</b>	9 mm	<b>C</b>	0.35 in	<b>D</b>	6 mm
<b>D</b>	0.24 inch	<b>G</b>	6 mm	<b>G</b>	0.26 in
	103 g		Dissipative		