



## HS 7280

Long Precision 45° Reverse angle  
& HS Long 45° Reverse Angle  
Cutters 0.2 mm-08 mm







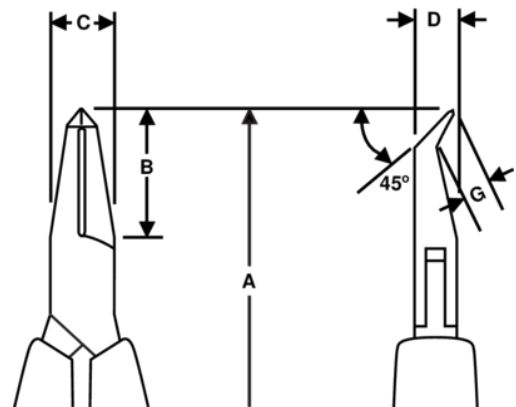

### PRODUCT DETAILS

- HS series and reverse angle oblique cutter
- ESD safe long foam handles with return spring
- Flush cut
- The stated cutting capacity is for copper wire
- Suitable for cutting copper
- High performance alloy steel
- Polished finish
- Numerically controlled machine grinding ensures edge angle accuracy and contact, increasing tool reliability and consistency
- Precision induction hardened edges 63-65 HRC
- Screw joint minimises friction and maximises alignment of cutting edges
- Ideal for use in confined spaces



PRODUCT ATTRIBUTES

Product: **HS7280**

	Angle 45°		S		Flush
	0.2-0.8 mm		0.01-0.03 in	<b>A</b>	150.3 mm
<b>A</b>	5.91 in	<b>B</b>	18 mm	<b>B</b>	0.71 in
<b>C</b>	9 mm	<b>C</b>	0.35 in	<b>D</b>	6 mm
<b>D</b>	0.24 inch	<b>G</b>	3.5 mm	<b>G</b>	0.14 in
	102 g	<b>Ω</b>	Dissipative		