



RX 8136-RX 8168 ERGO™ Precision Diagonal Cutters with Tapered & Relieved Head







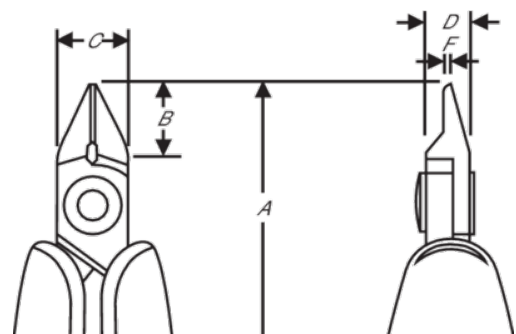

PRODUCT DETAILS

- Precision extra tapered & relieved head diagonal cutters developed according to the scientific ERGO™ process
- Extra Tapered & relieved head
- ERGO™ handles with two-component combination, thermoplastic surface, for comfortable grip, on tough polypropylene core for rigidity
- Flush & ultra-flush
- The cutting capacity that is given is for copper wire
- Cutting capacity: 0.1 mm-0.8 mm
- High performance alloyed steel
- Burnished finish
- Numerically controlled machine grinding guarantees edge angle accuracy & contact, increases the tool's reliability & consistency
- Precision induction-hardened edges 63-65 HRC
- Screw joint minimises friction & maximises alignment of cutting edges
- ESD safe handles in two-component synthetic material
- Bio spring limits the tension throughout the working cycle of the tool & can be adjusted to 3 different positions or removed
- Ideal for use in confined spaces & for rework thanks to the thinner tip head









PRODUCT ATTRIBUTES







Product: RX8136

	Tapered & Relieved		XS		Micro-Bevel®
	0.1-0.8 mm		0.004-0.03 in	A	108 mm
A	4.25 in	B	8 mm	B	0.31 in
C	8 mm	C	0.31 in	D	5 mm
D	0.2 inch	F	0.8 mm	F	0.03 in
	66 g		Dissipative		







Product: RX 8137

	Tapered & Relieved		XS		Flush
	0.1-0.8 mm		0.004-0.03 in	A	108 mm
A	4.25 in	B	8 mm	B	0.31 in
C	8 mm	C	0.31 in	D	5 mm
D	0.2 inch	F	0.8 mm	F	0.03 in
	66 g		Dissipative		







Product: RX8138

	Tapered & Relieved		XS		Ultra-Flush®
	0.1-0.5 mm		0.004-0.02 in	A	108 mm
A	4.25 in	B	8 mm	B	0.31 in
C	8 mm	C	0.31 in	D	5 mm
D	0.2 inch	F	0.8 mm	F	0.03 in
	66 g		Dissipative		







Product: RX 8146

	Tapered & Relieved		S		Micro-Bevel®
	0.2-1.0 mm		0.01-0.04 in	A	135.5 mm
A	5.25 in	B	10.5 mm	B	0.41 in
C	10 mm	C	0.39 in	D	6 mm
D	0.24 inch	F	0.8 mm	F	0.03 in
	68 g		Dissipative		







Product: RX 8147

	Tapered & Relieved		S		Flush
	0.1-1.0 mm		0.00-0.04 in	A	135.5 mm
A	5.25 in	B	10.5 mm	B	0.41 in
C	10 mm	C	0.39 in	D	6 mm
D	0.24 inch	F	0.8 mm	F	0.03 in
	68 g		Dissipative		







Product: RX 8148

	Tapered & Relieved		S		Ultra-Flush®
	0.1-0.8 mm		0.00-0.03 in	A	135.5 mm
A	5.25 in	B	10.5 mm	B	0.41 in
C	10 mm	C	0.39 in	D	6 mm
D	0.24 inch	F	0.8 mm	F	0.03 in
	68 g		Dissipative		







Product: RX 8156

	Tapered & Relieved		M		Micro-Bevel®
	0.3-1.25 mm		0.01-0.05 in	A	138 mm
A	5.30 in	B	13 mm	B	0.51 in
C	12.5 mm	C	0.49 in	D	6 mm
D	0.24 inch	F	1.2 mm	F	0.05 in
	70 g		Dissipative		







Product: RX 8157

	Tapered & Relieved		M		Flush
	0.2-1.25 mm		0.01-0.05 in	A	138 mm
A	5.30 in	B	13 mm	B	0.51 in
C	12.5 mm	C	0.49 in	D	6 mm
D	0.24 inch	F	1.2 mm	F	0.05 in
	70 g		Dissipative		







Product: RX 8158

	Tapered & Relieved		M		Ultra-Flush®
	0.2-1.0 mm		0.01-0.04 in	A	138 mm
A	5.30 in	B	13 mm	B	0.51 in
C	12.5 mm	C	0.49 in	D	6 mm
D	0.24 inch	F	1.2 mm	F	0.05 in
	70 g		Dissipative		







Product: RX8166

	Tapered & Relieved		L		Micro-Bevel®
	0.4-1.5 mm		0.02-0.06 in	A	147 mm
A	5.80 in	B	16 mm	B	0.63 in
C	16 mm	C	0.63 in	D	8 mm
D	0.31 inch	F	1.6 mm	F	0.06 in
	139 g		Dissipative		

Product: RX 8167

	Tapered & Relieved		L		Flush
	0.3-1.5 mm		0.01-0.06 in	A	147 mm
A	5.80 in	B	16 mm	B	0.63 in
C	16 mm	C	0.63 in	D	8 mm
D	0.31 inch	F	1.6 mm	F	0.06 in
	139 g		Dissipative		

Product: RX 8168

	Tapered & Relieved		L		Ultra-Flush®
	0.3-1.25 mm		0.01-0.05 in	A	147 mm
A	5.80 in	B	16 mm	B	0.63 in
C	16 mm	C	0.63 in	D	8 mm
D	0.31 inch	F	1.6 mm	F	0.06 in
	139 g		Dissipative		