



**8136-8168**

**Precision Diagonal Cutters with  
Tapered Head & Relieved & ESD  
Safe Handle**







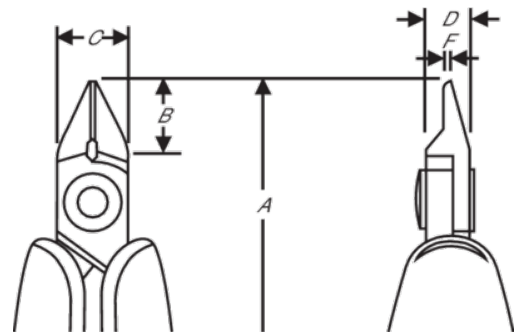











**PRODUCT DETAILS**

- 80 series precision diagonal cutters with tapered & relieved head
- ESD safe mono-material handles with return spring
- Micro-bevel, flush & ultra-flush cut
- The stated cutting capacity is for copper wire
- Suitable for cutting copper
- High performance alloy steel
- Burnished finish
- Numerically controlled machine grinding ensures edge angle accuracy and contact, increasing tool reliability and consistency
- Precision induction hardened edges 63-65 HRC
- Screw joint minimises friction and maximises alignment of cutting edges
- Ideal for use in confined spaces and for rework



















# PRODUCT ATTRIBUTES

















**Product: 8136**

	Tapered & Relieved		XS		Micro-Bevel ®
	0.1-0.8 mm		0.004-0.03 in		108 mm
	4.25 in		8 mm		0.31 in
	8 mm		0.31 in		5 mm
	0.2 inch		0.6 mm		0.02 in
	43 g		Dissipative		

















**Product: 8137**

	Tapered & Relieved		XS		Flush
	0.1-0.8 mm		0.004-0.03 in		108 mm
	4.25 in		8 mm		0.31 in
	8 mm		0.31 in		5 mm
	0.2 inch		0.6 mm		0.02 in
	43 g		Dissipative		

















**Product: 8138**

	Tapered & Relieved		XS		Ultra-Flush ®
	0.1-0.5 mm		0.004-0.02 in		108 mm
	4.25 in		8 mm		0.31 in
	8 mm		0.31 in		5 mm
	0.2 inch		0.6 mm		0.02 in
	43 g		Dissipative		

















**Product: 8146**

	Tapered & Relieved		S		Micro-Bevel ®
	0.2-1.0 mm		0.01-0.04 in		110.5 mm
	4.33 in		10 mm		0.39 in
	10 mm		0.39 in		6 mm
	0.24 inch		0.8 mm		0.03 in
	46 g		Dissipative		

















**Product: 8147**

	Tapered & Relieved		S		Flush
	0.1-1.0 mm		0.01-0.04 in		110.5 mm
	4.33 in		10 mm		0.39 in
	10 mm		0.39 in		6 mm
	0.24 inch		0.8 mm		0.03 in
	46 g		Dissipative		

















**Product: 8148**

	Tapered & Relieved		S		Ultra-Flush ®
	0.1-0.8 mm		0.00-0.03 in		110.5 mm
	4.33 in		10 mm		0.39 in
	10 mm		0.39 in		6 mm
	0.24 inch		0.8 mm		0.03 in
	45 g		Dissipative		

















**Product: 8156**

	Tapered & Relieved		M		Micro-Bevel ®
	0.3-1.25 mm		0.01-0.05 in		112.5 mm
	4.43 in		12.5 mm		0.5 in
	12.5 mm		0.50 in		6 mm
	0.24 inch		1.2 mm		0.05 in
	49 g		Dissipative		

















**Product: 8157**

	Tapered & Relieved		M		Flush
	0.2-1.25 mm		0.01-0.05 in		112.5 mm
	4.43 in		12.5 mm		0.5 in
	12.5 mm		0.50 in		6 mm
	0.24 inch		1.2 mm		0.05 in
	49 g		Dissipative		

















**Product: 8158**

	Tapered & Relieved		M		Ultra-Flush ®
	0.2-1.0 mm		0.01-0.04 in		112.5 mm
	4.43 in		12.5 mm		0.5 in
	12.5 mm		0.50 in		6 mm
	0.24 inch		1.2 mm		0.05 in
	49 g		Dissipative		

















**Product: 8166L**

	Tapered & Relieved		L		Micro-Bevel ®
	0.4-1.5 mm		0.02-0.06 in		125 mm
	4.92 in		16 mm		0.63 in
	16 mm		0.63 in		8 mm
	0.31 inch		1.6 mm		0.06 in
	52 g		Dissipative		

















**Product: 8167L**

	Tapered & Relieved		L		Flush
	0.3-1.5 mm		0.01-0.06 in		125 mm
	4.92 in		16 mm		0.63 in
	16 mm		0.63 in		8 mm
	0.31 inch		1.6 mm		0.06 in
	52 g		Dissipative		

**Product: 8168L**

	Tapered & Relieved		L		Ultra-Flush ®
	0.3-1.25 mm		0.01-0.05 in		125 mm
	4.92 in		16 mm		0.63 in
	16 mm		0.63 in		8 mm
	0.31 inch		1.6 mm		0.06 in
	51 g		Dissipative		

**Product: 8148 CO**

	Tapered & Relieved		S		Ultra-Flush ®
	0.1-0.8 mm		0.00-0.03 in		110 mm
	4.33 in		10 mm		0.39 in
	10 mm		0.39 in		6 mm
	0.24 inch		0.8 mm		0.03 in
	45 g		Conductive		