



8149

Precision Diagonal Tip Cutters with ESD Safe Handle







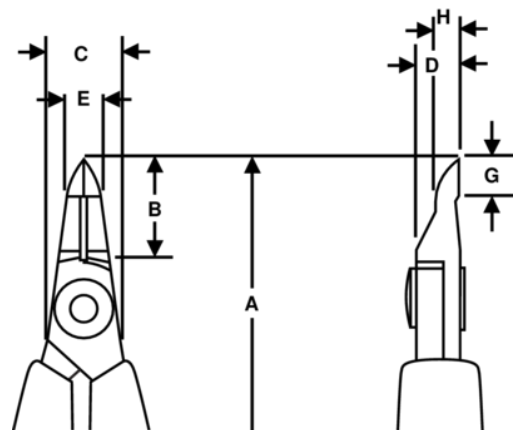
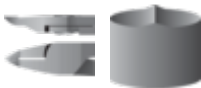

PRODUCT DETAILS

- 80 Series precision diagonal cutters with tip cut
- ESD safe mono-material handles with return spring
- Flush cut
- The cutting capacity given is for copper wire
- Suitable for cutting Cu
- High performance alloyed steel
- Burnished finish
- Numerically controlled machine grinding guarantees edge angle accuracy & contact, increases the tools reliability & consistency
- Precision induction hardened edges 58-60 HRC
- Screw joint that minimizes friction & maximizes alignment of cutting edges
- Ideal for use with multi-lead components & for rework
- CO standard handle shape in conductive material



PRODUCT ATTRIBUTES

Product: **8149**

	Tip Cutter		S		Flush
	0.1-0.6 mm		0.00-0.02 in	A	114 mm
A	4.49 in	B	14 mm	B	0.55 in
C	5 mm	C	0.23 in	D	6 mm
D	0.24 inch	E	5 mm	E	0.23 in
G	5 mm	G	0.23 in	H	3.2 mm
H	0.13 in		48 g	Ω	Dissipative