



7892

60° Bent Tip Snipe Nose Pliers with Synthetic Handle





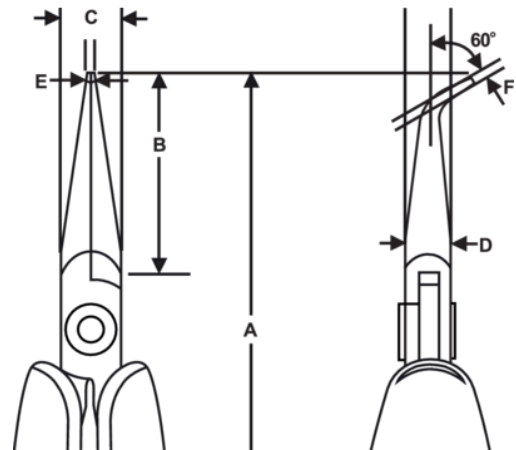

PRODUCT DETAILS

- Supreme series snipe nose pliers with bent tip
- ESD safe mono-material handles with return spring
- High performance alloyed steel
- Polished finish
- Numerically controlled machine grinding guarantees accuracy & increases the tools reliability & consistency
- Tough hardened 42-46 HRC
- Screw joint that minimizes friction & maximizes jaw alignment
- 29 mm of smooth jaws bent at 60° with radiused edges







PRODUCT ATTRIBUTES

Product: **7892**

| | | | | | |
|---|-----------|---|-------------|---|----------|
|  | Bent Nose |  | M | A | 129.0 mm |
| A | 5.08 in | B | 29 mm | B | 1,14 in |
| C | 9 mm | C | 0.35 in | D | 6 mm |
| D | 0,24 inch | E | 1,2 mm | E | 0,05 in |
| F | 0,8 mm | F | 0,03 in |  | Smooth |
|  | 73 g | Ω | Dissipative | | |

Product: **7892 CO**

| | | | | | |
|---|-----------|---|------------|---|----------|
|  | Bent Nose |  | M | A | 129.0 mm |
| A | 5.08 in | B | 29 mm | B | 1,14 in |
| C | 9 mm | C | 0.35 in | D | 6 mm |
| D | 0,24 inch | E | 1,2 mm | E | 0,05 in |
| F | 0,8 mm | F | 0,03 in |  | Smooth |
|  | 73 g | Ω | Conductive | | |