



TRX 8180 Heavy Duty Diagonal Cutters with Dual-Component Handle







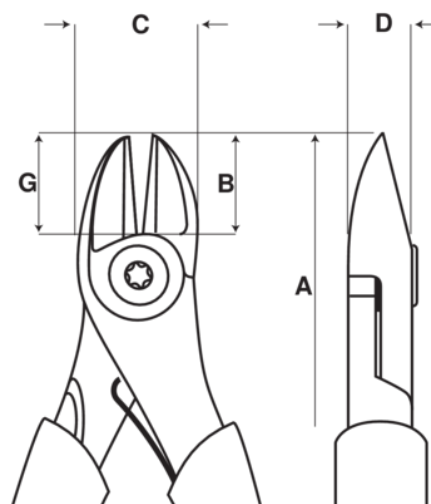





PRODUCT DETAILS

- Heavy duty cutter
- Handles with two-component combination, thermoplastic surface on tough polypropylene which gives superior grip
- Cutting capacity: 4.5 mm Cu, 3 mm Fe+ & 2.5 mm of piano wire
- Equipped with a return spring featuring & on/off function
- High performance alloyed steel
- Burnished finish, anti-corrosion treated
- High leverage side cutting pliers
- induction-hardened cutting edges
- Progressive edges: the cutting radius progresses along the edge in order to cut hard material
- Piano wire close to the joint & soft materials like copper & plastic insulated wire at the tip
- Screw joint provides excellent running & accurate alignment of the cutting edges
- High leverage: redesigned for optimum cutting performance & reduced cutting effort



PRODUCT ATTRIBUTES

Product: **TRX 8180**

	Oval		L		Progressive Bevel
	4.5 mm		0.177 in		3.0 mm
	0.118 in		2.5 mm		0.10 in
A	210 mm	A	8.26 in	B	21 mm
B	0.82 in	C	29 mm	C	1.141 in
D	11 mm	D	0.433 inch		304 g