



HS7191

**Long Micro-Bevel® Cut Diagonal
Cutter with Tapered Head & ESD
Safe Conductive Material Handle
0.2 mm-1 mm**







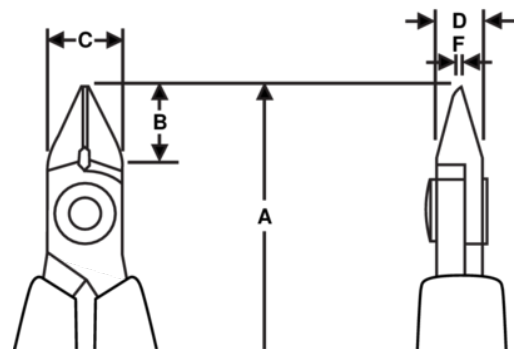

PRODUCT DETAILS

- HS series tapered head cutting pliers
- ESD safe long foam handles with return spring
- Micro-bevel & flush cut
- The stated cutting capacity is for copper wire
- Suitable for cutting copper
- High performance alloy steel
- Polished finish
- Numerically controlled machine grinding ensures edge angle accuracy and contact, increasing tool reliability and consistency
- Precision induction hardened edges 63-65 HRC
- Screw joint minimises friction and maximises alignment of cutting edges



PRODUCT ATTRIBUTES

Product: **HS7191**

	Tapered		S		Flush
	0.1-1.0 mm		0.01-0.05 in	A	141.3 mm
A	5.56 in	B	9 mm	B	0.35 in
C	9 mm	C	0.35 in	D	6 mm
D	0.24 inch	F	1 mm	F	0.04 in
	98 g	Ω	Dissipative		