



## HS7190

**Long Micro-Bevel® Cut Diagonal  
Cutter with Tapered Head & ESD  
Safe Handle 0.2 mm-1 mm**







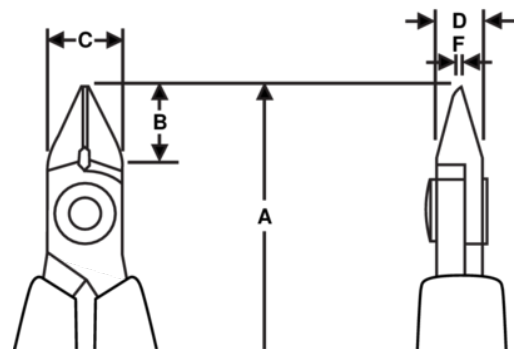

### PRODUCT DETAILS

- HS series tapered head cutting pliers
- ESD safe long foam handles with return spring
- Micro-bevel & flush cut
- The stated cutting capacity is for copper wire
- Suitable for cutting copper
- High performance alloy steel
- Polished finish
- Numerically controlled machine grinding ensures edge angle accuracy and contact, increasing tool reliability and consistency
- Precision induction hardened edges 63-65 HRC
- Screw joint minimises friction and maximises alignment of cutting edges



PRODUCT ATTRIBUTES

Product: **HS7190**

	Tapered		S		Micro-Bevel®
	0.2-1.0 mm		0.01-0.05 in	<b>A</b>	141.3 mm
<b>A</b>	5.56 in	<b>B</b>	9 mm	<b>B</b>	0.35 in
<b>C</b>	9 mm	<b>C</b>	0.35 in	<b>D</b>	6 mm
<b>D</b>	0.24 inch	<b>F</b>	1 mm	<b>F</b>	0.04 in
	98 g		Dissipative		