



HS8211

Long Precision 20° Short Head Oblique Cutters 0.2 mm-1.2 mm







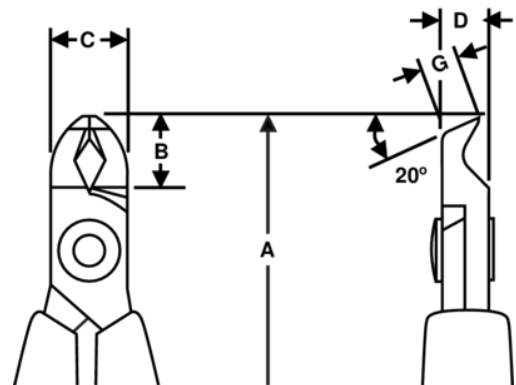

PRODUCT DETAILS

- HS series precision oblique cutter with short head
- ESD safe long foam handles with return spring
- Flush cut
- The stated cutting capacity is for copper wire
- Suitable for cutting copper
- High performance alloy steel
- Burnished finish
- Numerically controlled machine grinding ensures edge angle accuracy and contact, increasing tool reliability and consistency
- Precision induction hardened edges 63-65 HRC
- Screw joint minimises friction and maximises alignment of cutting edges
- Ideal for rework and close assembly needs



PRODUCT ATTRIBUTES

Product: **HS8211**

| | | | | | |
|---|------------|---|--------------|---|---------|
|  | Angle 20° |  | L |  | Flush |
|  | 0.2-1.2 mm |  | 0.01-0.05 in | A | 5.60 mm |
| A | 142.3 in | B | 9.5 mm | B | 0.37 in |
| C | 10 mm | C | 0.39 in | D | 8 mm |
| D | 0.31 inch | G | 4.1 mm | G | 0.16 in |
|  | 91 g |  | Dissipative | | |