

HS8167

Long Ultra-Flush® Precision Cut Diagonal Cutter with Tapered & Relieved Head & ESD Safe Handle 0.3-1.5 mm







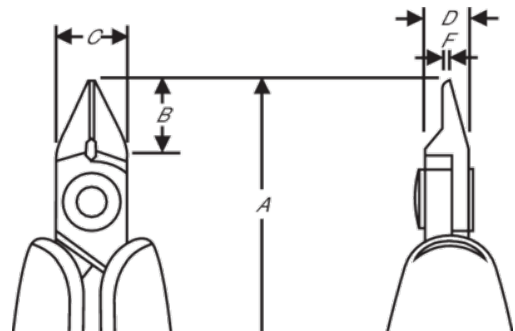

PRODUCT DETAILS

- HS series precision diagonal cutters with tapered & relieved head
- ESD safe long foam handles with return spring
- Micro-bevel, flush & ultra-flush cut
- The stated cutting capacity is for copper wire
- Suitable for cutting copper
- High performance alloy steel
- Burnished finish
- Numerically controlled machine grinding ensures edge angle accuracy and contact, increasing tool reliability and consistency
- Precision induction hardened edges 63-65 HRC
- Screw joint minimises friction and maximises alignment of cutting edges
- Ideal for wire harness work and standard printed circuit board assembly



PRODUCT ATTRIBUTES

Product: **HS8167**

	Tapered & Relieved		L		Flush
	0.3-1.5 mm		0.01-0.06 in	A	125 mm
A	4.92 in	B	16 mm	B	0.63 in
C	16 mm	C	0.63 in	D	8 mm
D	0.31 inch	F	1.6 mm	F	0.06 in
	139 g		Dissipative		