

HS8166

Long Ultra-Flush® Precision Cut Diagonal Cutter with Tapered & Relieved Head & ESD Safe Handle 0.3-1.5 mm







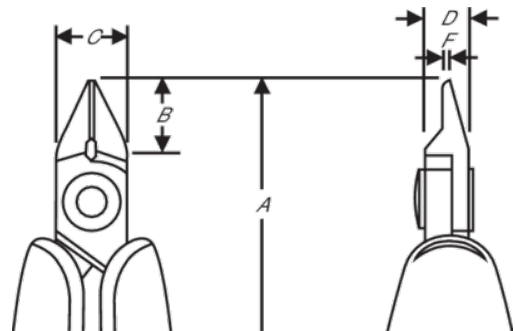

PRODUCT DETAILS

- HS series precision diagonal cutters with tapered & relieved head
- ESD safe long foam handles with return spring
- Micro-bevel, flush & ultra-flush cut
- The stated cutting capacity is for copper wire
- Suitable for cutting copper
- High performance alloy steel
- Burnished finish
- Numerically controlled machine grinding ensures edge angle accuracy and contact, increasing tool reliability and consistency
- Precision induction hardened edges 63-65 HRC
- Screw joint minimises friction and maximises alignment of cutting edges
- Ideal for wire harness work and standard printed circuit board assembly



PRODUCT ATTRIBUTES

Product: **HS8166**

| | | | | | |
|---|--------------------|---|--------------|---|--------------|
|  | Tapered & Relieved |  | L |  | Micro-Bevel® |
|  | 0.4-1.5 mm |  | 0.02-0.06 in | A | 125 mm |
| A | 4.92 in | B | 16 mm | B | 0.63 in |
| C | 16 mm | C | 0.63 in | D | 8 mm |
| D | 0.31 inch | F | 1.6 mm | F | 0.06 in |
|  | 139 g |  | Dissipative | | |