

## HS8158

### Long Ultra-Flush® Precision Cut Diagonal Cutter with Tapered & Relieved Head & ESD Safe Handle 0.2-1 mm







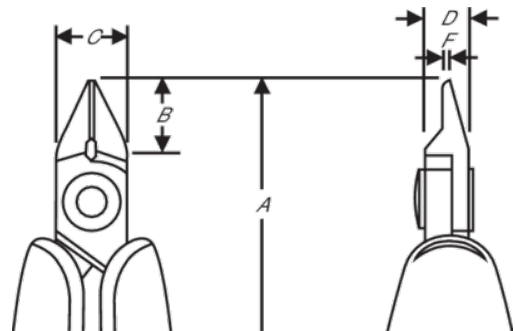

#### PRODUCT DETAILS

- HS series precision diagonal cutters with tapered & relieved head
- ESD safe long foam handles with return spring
- Micro-bevel, flush & ultra-flush cut
- The stated cutting capacity is for copper wire
- Suitable for cutting copper
- High performance alloy steel
- Burnished finish
- Numerically controlled machine grinding ensures edge angle accuracy and contact, increasing tool reliability and consistency
- Precision induction hardened edges 63-65 HRC
- Screw joint minimises friction and maximises alignment of cutting edges
- Ideal for wire harness work and standard printed circuit board assembly



PRODUCT ATTRIBUTES

Product: **HS8158**

	Tapered & Relieved		M		Ultra-Flush®
	0.2-1.0 mm		0.01-0.04 in	<b>A</b>	144.8 mm
<b>A</b>	5.70 in	<b>B</b>	12.5 mm	<b>B</b>	0.5 in
<b>C</b>	12.5 mm	<b>C</b>	0.49 in	<b>D</b>	6 mm
<b>D</b>	0.24 inch	<b>F</b>	1 mm	<b>F</b>	0.04 in
	97 g	<b>Ω</b>	Dissipative		