



HS8138

Long Ultra-Flush® Precision Cut Diagonal Cutter with Oval Head & ESD Safe Handle 0.1-0.5 mm







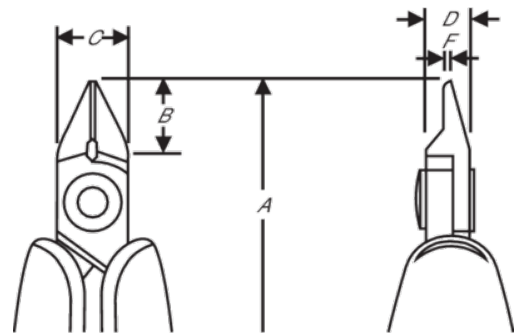

PRODUCT DETAILS

- HS series precision diagonal cutters with tapered & relieved head
- ESD safe long foam handles with return spring
- Micro-bevel, flush & ultra-flush cut
- The stated cutting capacity is for copper wire
- Suitable for cutting copper
- High performance alloy steel
- Burnished finish
- Numerically controlled machine grinding ensures edge angle accuracy and contact, increasing tool reliability and consistency
- Precision induction hardened edges 63-65 HRC
- Screw joint minimises friction and maximises alignment of cutting edges
- Ideal for wire harness work and standard printed circuit board assembly



PRODUCT ATTRIBUTES

Product: **HS8138**

	Tapered & Relieved		XS		Ultra-Flush®
	0.1-0.5 mm		0.004-0.02 in	A	140.3 mm
A	5.52 in	B	8 mm	B	0.31 in
C	8 mm	C	0.31 in	D	5 mm
D	0.2 inch	F	0.8 mm	F	0.03 in
	91 g	Ω	Dissipative		