



RX 8157

ERGO™ Flush Precision Cut Diagonal Cutter with Tapered & Relieved Head 0.2-1.25 mm







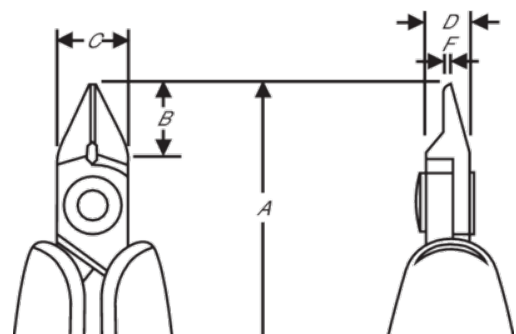

PRODUCT DETAILS

- Precision extra tapered & relieved head diagonal cutters developed according to the scientific ERGO™ process
- Extra Tapered & relieved head
- ERGO™ handles with two-component combination, thermoplastic surface, for comfortable grip, on tough polypropylene core for rigidity
- Flush & ultra-flush
- The cutting capacity that is given is for copper wire
- Cutting capacity: 0.1 mm-0.8 mm
- High performance alloyed steel
- Burnished finish
- Numerically controlled machine grinding guarantees edge angle accuracy & contact, increases the tool's reliability & consistency
- Precision induction-hardened edges 63-65 HRC
- Screw joint minimises friction & maximises alignment of cutting edges
- ESD safe handles in two-component synthetic material
- Bio spring limits the tension throughout the working cycle of the tool & can be adjusted to 3 different positions or removed
- Ideal for use in confined spaces & for rework thanks to the thinner tip head



PRODUCT ATTRIBUTES

Product: **RX 8157**

	Tapered & Relieved		M		Flush
	0.2-1.25 mm		0.01-0.05 in	A	138 mm
A	5.30 in	B	13 mm	B	0.51 in
C	12.5 mm	C	0.49 in	D	6 mm
D	0.24 inch	F	1.2 mm	F	0.05 in
	70 g	Ω	Dissipative		