



RX 8168

**ERGO™ Ultra-Flush® Precision
Cut Diagonal Cutter with Tapered
& Relieved Head 0.3-1.25 mm**







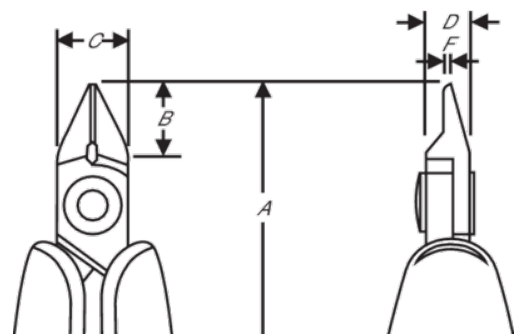

PRODUCT DETAILS

- Precision extra tapered & relieved head diagonal cutters developed according to the scientific ERGO™ process
- Extra Tapered & relieved head
- ERGO™ handles with two-component combination, thermoplastic surface, for comfortable grip, on tough polypropylene core for rigidity
- Flush & ultra-flush
- The cutting capacity that is given is for copper wire
- Cutting capacity: 0.1 mm-0.8 mm
- High performance alloyed steel
- Burnished finish
- Numerically controlled machine grinding guarantees edge angle accuracy & contact, increases the tool's reliability & consistency
- Precision induction-hardened edges 63-65 HRC
- Screw joint minimises friction & maximises alignment of cutting edges
- ESD safe handles in two-component synthetic material
- Bio spring limits the tension throughout the working cycle of the tool & can be adjusted to 3 different positions or removed
- Ideal for use in confined spaces & for rework thanks to the thinner tip head



PRODUCT ATTRIBUTES

Product: **RX 8168**

| | | | | | |
|---|--------------------|---|--------------|---|--------------|
|  | Tapered & Relieved |  | L |  | Ultra-Flush® |
|  | 0.3-1.25 mm |  | 0.01-0.05 in | A | 147 mm |
| A | 5.80 in | B | 16 mm | B | 0.63 in |
| C | 16 mm | C | 0.63 in | D | 8 mm |
| D | 0.31 inch | F | 1.6 mm | F | 0.06 in |
|  | 139 g | Ω | Dissipative | | |