



**8168L**

**Ultra-Flush® Precision Cut  
Diagonal Cutter with Tapered &  
Relieved Head & ESD Safe Handle  
0.3-1.5 mm**







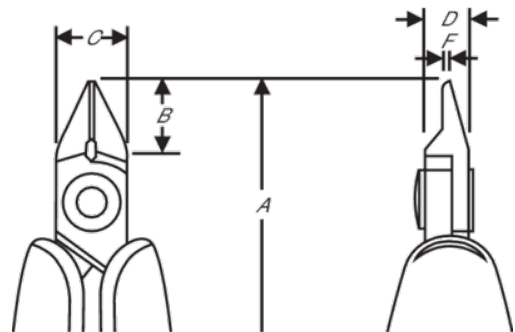

## PRODUCT DETAILS

- 80 series precision diagonal cutters with tapered & relieved head
- ESD safe mono-material handles with return spring
- Micro-bevel, flush & ultra-flush cut
- The stated cutting capacity is for copper wire
- Suitable for cutting copper
- High performance alloy steel
- Burnished finish
- Numerically controlled machine grinding ensures edge angle accuracy and contact, increasing tool reliability and consistency
- Precision induction hardened edges 63-65 HRC
- Screw joint minimises friction and maximises alignment of cutting edges
- Ideal for use in confined spaces and for rework



PRODUCT ATTRIBUTES

Product: **8168L**

	Tapered & Relieved		L		Ultra-Flush®
	0.3-1.25 mm		0.01-0.05 in	<b>A</b>	125 mm
<b>A</b>	4.92 in	<b>B</b>	16 mm	<b>B</b>	0.63 in
<b>C</b>	16 mm	<b>C</b>	0.63 in	<b>D</b>	8 mm
<b>D</b>	0.31 inch	<b>F</b>	1.6 mm	<b>F</b>	0.06 in
	51 g	<b>Ω</b>	Dissipative		