



HS 8130

Long Micro-Bevel® Precision Cut Diagonal Cutter with Oval Head & ESD Safe Handle 0.2-1 mm







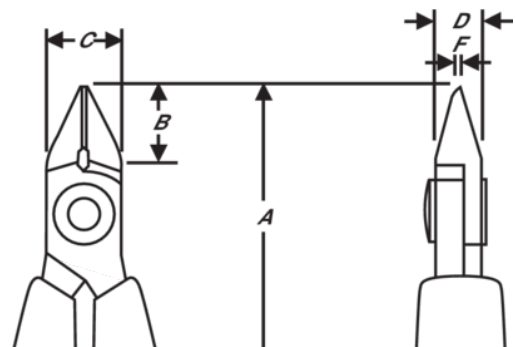



PRODUCT DETAILS

- HS series precision diagonal cutters
- ESD safe long foam handles with return spring
- Micro-bevel, flush & ultra-flush cut
- The stated cutting capacity is for copper wire
- Suitable for cutting copper
- High performance alloy steel
- Burnished finish
- Numerically controlled machine grinding ensures edge angle accuracy and contact, increasing tool reliability and consistency
- Precision induction hardened edges 63-65 HRC
- Screw joint minimises friction and maximises alignment of cutting edges
- Ideal for wire harness work and standard printed circuit board assembly



PRODUCT ATTRIBUTES

Product: **HS 8130**

	Oval		XS		Micro-Bevel®
	0.2-1.25 mm		0.01-0.05 in		
		A	140.3 mm	A	5.52 in
B	8 mm	B	0.31 in	C	8 mm
C	0.31 in	D	5 mm	D	0.2 inch
F	0.8 mm	F	0.03 in		91 g
Ω	Dissipative				