



RX 8149
ERGO™ Flush Precision Cut
Diagonal Tip Cutter 0.1-0.6 mm







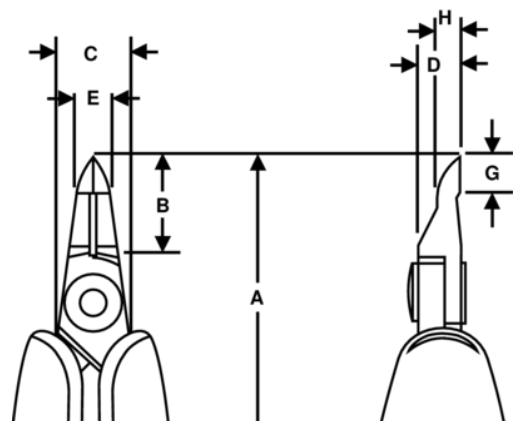

PRODUCT DETAILS

- Precision tip cutters developed according to the scientific ERGO™ process
- ERGO™ handles with two-component combination, thermoplastic surface, for comfortable grip, on tough polypropylene core for rigidity
- Flush cut
- The cutting capacity that is given is for copper wire
- Cutting capacity: 0.1 mm to 0.6 mm
- High performance alloyed steel
- Burnished finish
- Numerically controlled machine grinding guarantees edge angle accuracy & contact, increases the tool's reliability & consistency
- Precision induction-hardened edges 58-60 HRC
- Screw joint minimises friction & maximises alignment of cutting edges
- ESD safe handles in two-component synthetic material
- Bio spring limits the tension throughout the working cycle of the tool & can be adjusted to 3 different positions or removed
- Ideal for use with multi-lead components & for rework



PRODUCT ATTRIBUTES

Product: **RX 8149**

	Tip Cutter		S		Flush
	0.1-0.6 mm		0.01-0.02 in	A	139 mm
A	5.47 in	B	14 mm	B	0.55 in
C	10 mm	C	0.39 in	D	6 mm
D	0.24 inch	E	5 mm	E	0.2 in
G	5 mm	G	0.2 in	H	3.2 mm
H	0.13 in		70 g	Ω	Dissipative