



RX 8152

**ERGO™ Ultra-Flush® Precision
Cut Diagonal Cutter with Oval
Head 0.2-1.25 mm**







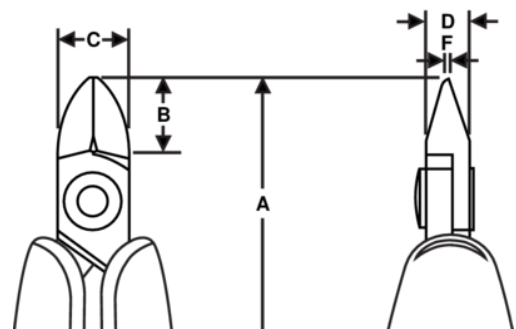



PRODUCT DETAILS

- Precision oval head diagonal cutters developed according to the scientific ERGO™ process, Oval head
- ERGO™ handles with two-component combination, thermoplastic surface, for comfortable grip, on tough polypropylene core for rigidity
- Micro-bevel, flush & ultra-cut
- The cutting capacity that is given is for copper wire
- Cutting capacity: 0.1 mm-0.8 mm to 0.4 mm-2 mm
- High performance alloyed steel
- Burnished finish
- Numerically controlled machine grinding guarantees edge angle accuracy & contact, increases the tool's reliability & consistency
- Precision induction-hardened edges 63-65 HRC
- Screw joint minimises friction & maximises alignment of cutting edges
- ESD safe handles in two-component synthetic material
- Bio spring limits the tension throughout the working cycle of the tool & can be adjusted to 3 different positions or removed
- Ideal for wire harness work & standard printed circuit board assembly



PRODUCT ATTRIBUTES

Product: **RX 8152**

	Oval		M		Ultra-Flush®
	0.2-1.25 mm		0.00-0.05 in		
		A	138 mm	A	5.43 in
B	13 mm	B	0.51 in	C	12.5 mm
C	0.49 in	D	6 mm	D	0.24 inch
F	1.2 mm	F	0.05 in		73 g
Ω	Dissipative				