



RX 8211

ERGO™ Flush Cut Short Precision 20° Angle Head Oblique Cutter 0.2 -1.2 mm







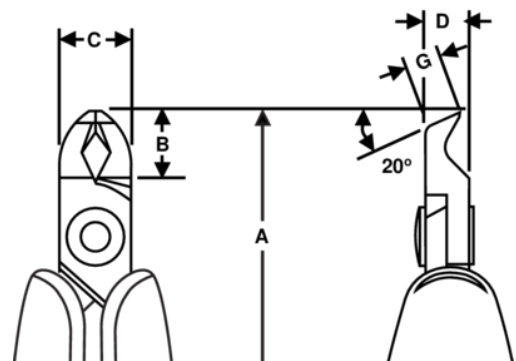

PRODUCT DETAILS

- Precision oblique cutters 20° Short Head developed according to the scientific ERGO™ process
- ERGO™ handles with two-component combination, thermoplastic surface, for comfortable grip, on tough polypropylene core for rigidity
- Flush cut
- The cutting capacity that is given is for copper wire
- Cutting capacity: 0.2 mm to 1.2 mm Cu
- High performance alloyed steel
- Burnished finish
- Numerically controlled machine grinding guarantees edge angle accuracy & contact, increases the tool's reliability & consistency
- Precision induction-hardened edges 63-65 HRC
- Screw joint minimises friction & maximises alignment of cutting edges
- ESD safe handles in two-component synthetic material
- Bio spring limits the tension throughout the working cycle of the tool & can be adjusted to 3 different positions or removed
- Ideal for rework & close assembly needs



PRODUCT ATTRIBUTES

Product: **RX 8211**

	Angle 20°		S		Flush
	0.2-1.2 mm		0.01-0.05 in	A	134.5 mm
A	5.29 in	B	9.5 mm	B	0.37 in
C	10 mm	C	0.39 in	D	6 mm
D	0.24 inch	G	4.1 mm	G	0.16 in
	70 g	Ω	Dissipative		