



## HS6000

### Multipurpose Shear with Non-Slip Grip and Smooth Jaws 145 mm







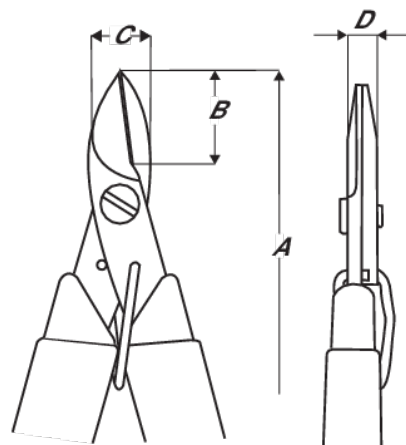

## PRODUCT DETAILS

- Kevlar cutter
- Designed to cut tough Kevlar elements used in fibre optic & other types of cables
- High carbon steel blades with a hardness of 57-59 HRC
- Serrations on one edge to prevent the material being cut from sliding away
- Precision screw joint minimises friction & maximises alignment of cutting edges
- User-friendly while optimising durability & precision
- Fits comfortably in either hand
- ESD safe non-slip grips provide cushioning & secure grasp
- Ideal for many other applications such as cutting insulation, cables, ties & corded material of all types



PRODUCT ATTRIBUTES

Product: **HS6000**

|   |               |   |        |   |             |
|---|---------------|---|--------|---|-------------|
|  | Serrated-Jaws |  | L      |  | Flush       |
|  | Kevlar        | <b>A</b>  | 145 mm | <b>A</b>  | 5.7 in      |
| <b>B</b>  | 29 mm         | <b>B</b>  | 1.1 in | <b>C</b>  | 12.7 mm     |
| <b>C</b>  | 0.5 in        | <b>D</b>  | 6.4 mm | <b>D</b>  | 0.2 inch    |
|  | Serrated      |  | 88 g   |  | Dissipative |